

# POST FORM profiles

FRONT EDGE profiles

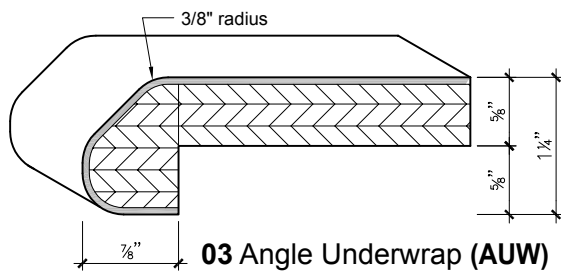

# FLATLAY profiles

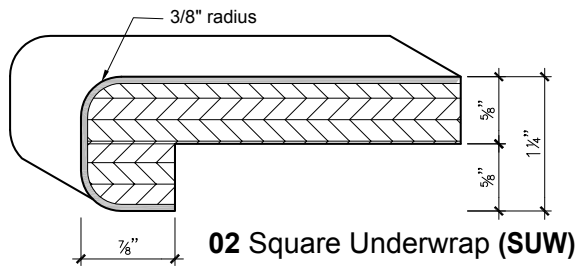
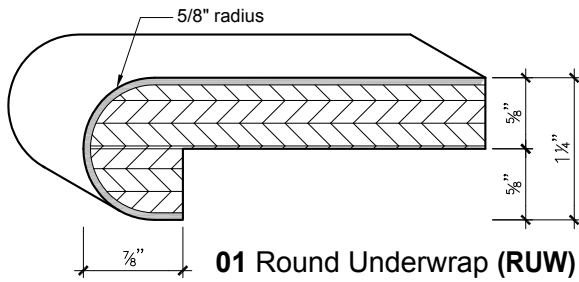
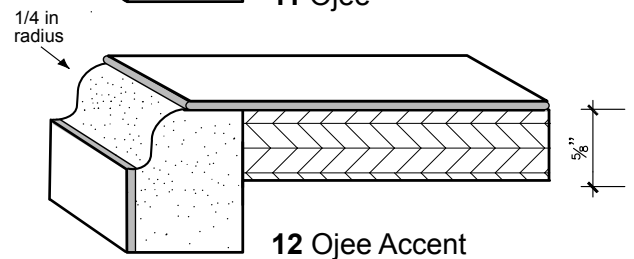
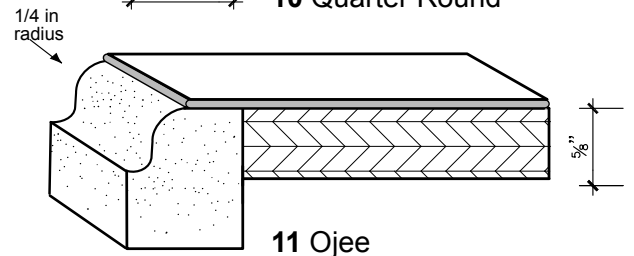
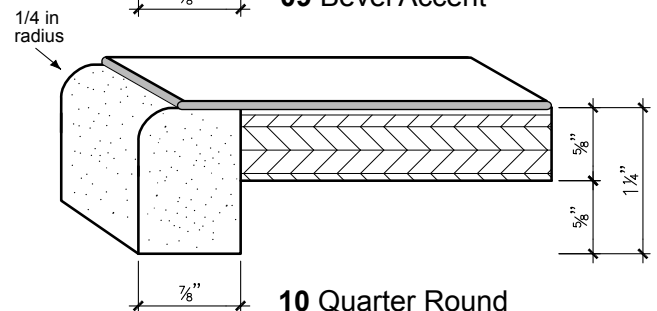
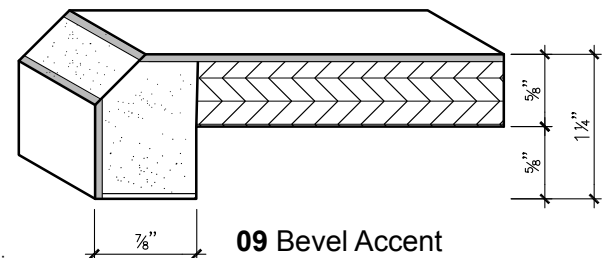
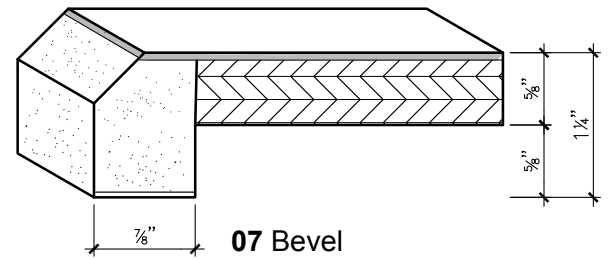
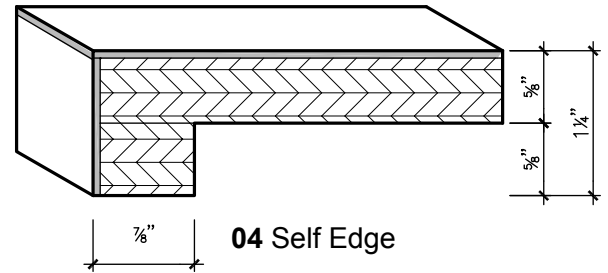

BACKSPLASH details

**001 Round Underwrap (RUW)**

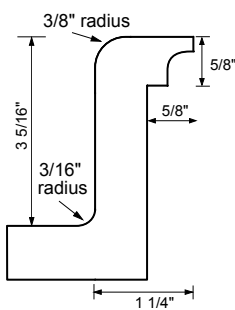

**002 Square Underwrap (SUW)**

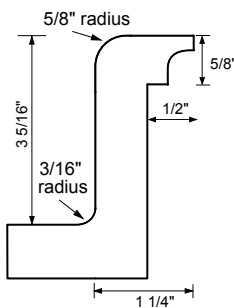

**003 Angle Underwrap (AUW)**

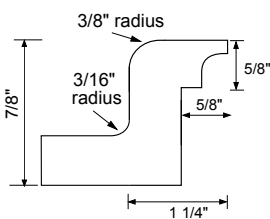

**004 1 Inch Backsplash**

## FITS RIGHT COUNTERTOPS

tel **1.877.882.0080**

fax **1.877.882.8388**

For more info visit our website: [www.fitsright.ca](http://www.fitsright.ca)

Note: Other profiles available upon request. Upcharges may apply.

## PROFILE LEGEND

